



DESCRIPTION

Digital panel controller with 4-digit LED display.

The panel controller is used for control and measurement of:

- AC/DC voltage.
- AC/DC current.
- Temperature with Pt-100/500/1000, Ni-100, thermistors and thermo-couples. The temperature measurement is fully linearized by the built-in microprocessor.
- Standard process signals.

The actual input signal type and measuring range must be specified when the panel controller is ordered.

Splash proof front panel with integrated display, LED indicators and 4 button keypad for programming and adjustment.

The panel controller is microprocessor based and fully programmable from the keypad:

- Output relay mode selection with 6 different output modes.
- Scale minimum/maximum.
- Decimal point position.
- Setpoint (1 or 2).
- Hysteresis (below or above setpoint).
- Correction of read-out (in case of deviation between actual measuring value and read-out).
- Display update time (0-10.0 sec.).
- On delay, output relay 1 & 2 individually (0-100.0 sec.).
- Release delay, output relay 1 & 2 individually (0-100.0 sec.).

The settings are stored in an EEPROM and accidental change of preprogrammed settings is avoided through the keyboard lock facility.

One or two output relays (UDC-32) with LED indication of energized relay.

Standardized housing (96 x 48 mm) with plug-in terminals at the rear. Versions with galvanic isolation between input signal and power supply.

REAR PANEL/CONNECTIONS

Rear panel

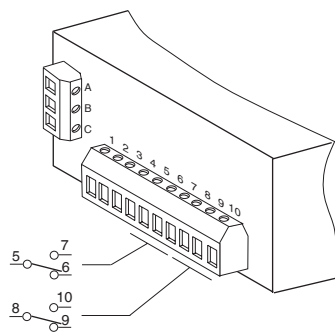

Supply voltage

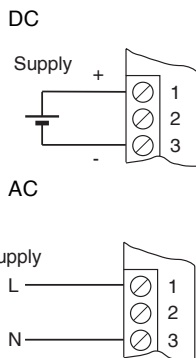

OUTPUT RELAY MODES

The two output relays can be programmed to perform one of 6 functions¹⁾.

Mode	Function	Application example
------	----------	---------------------

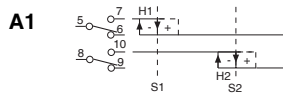

Two level heater
Relay 1: High level.
Relay 2: Basic level.
2 separate setpoints.

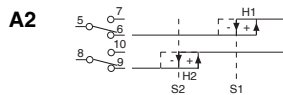

Two level indicator
Relay 1: Level 1.
Relay 2: Level 2.
2 separate setpoints.

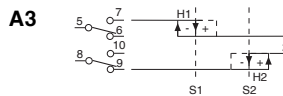

Alarm
Relay 1: Lower limit.
Relay 2: Upper limit.
2 separate setpoints.

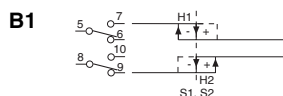

Heating/cooling
Relay 1: Controls heating.
Relay 2: Controls cooling.
Common setpoint.

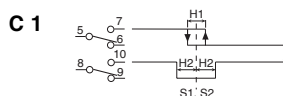

Heating/alarm
Relay 1: Controls heating.
Relay 2: Alarm low and high limit.
Common setpoint.

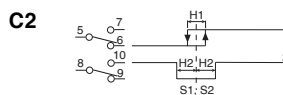

Cooling/alarm
Relay 1: Controls cooling
Relay 2: Alarm low and high limit.
Common setpoint.

VERSION/ORDERING CODES

Type:	UDC-32	2	230	P1
Output relay: 2 output relays.	2	-----		
Supply voltage: 24V AC 48V AC 110/120V AC 220/240V AC 24V DC	024 048 115 230 G24	-----		
Input:		-----		
Current:		-----		
DC:	DC ³⁾	-----		
0-99.99mA.	DC1	-----		
0-200.0mA.	DC2	-----		
0-10.00A.	DC3 ¹⁾	-----		
0-100.0A.	DC4 ¹⁾	-----		
AC:	AC ³⁾	-----		
0-200.0mA.	AC2	-----		
0-5.000A.	AC3 ⁴⁾	-----		
Voltage:		-----		
DC:	DV ³⁾	-----		
0-99.99V.	DV2	-----		
0-500.0V.	DV3	-----		
AC:	AV ³⁾	-----		
0-99.99V.	AV2	-----		
0-500.0V.	AV3	-----		
RTDs:		-----		
Pt-100:	P ³⁾	-----		
-19.95-99.95°C.	P1	-----		
-50.0-300.0°C.	NP2	-----		
-50-850°C.	P3	-----		
Pt-500:	P ³⁾	-----		
-19.95-99.95 °C.	P51	-----		
-50.0-300.0 °C.	P52	-----		
-50-850 °C.	P53	-----		
Pt-1000:	P ³⁾	-----		
-19.95-99.95 °C.	P11	-----		
-50.0-300.0 °C.	P12	-----		
-50 -850 °C.	P13	-----		
Ni-100:	N ³⁾	-----		
-50.0-300.0°C.	NP2	-----		
Thermistor (KTY):	T ³⁾	-----		
-30.0-100.0°C.	T1	-----		
Thermocouples:		-----		
Fe-CuNi:	J ³⁾	-----		
-50-1200°C.	J1	-----		
NiCr-Ni:	K ³⁾	-----		
-50-1350°C.	K1	-----		
PtRh-Pt 10%:	S ³⁾	-----		
-50-1750°C.	S1	-----		
PtRh-Pt 13%:	R ³⁾	-----		
-50-1750°C.	R1	-----		
Standard process signals: ³⁾		-----		
0-20mA DC/0-10V DC	U1	-----		

TECHNICAL DATA

Temperature drift:	Max. 0.01% per °C.
Hysteresis:	Adjustable inside the defined scale, above or below setpoint.
Display:	4 digit LED-type (-1999 to 9999).
Digit height:	14 mm.
Update time:	Programmable 0-10sec, 0.1sec. resolution.
Scale:	Programmable scale min. and max. within the limits of the display (-1999 to 9999).
Decimal point:	Programmable _ _ _ _ _
Indicators:	
S1/S2 (green):	Output relay activated.
P1/P2 (red):	Programming of parameters.
Output relay:	UDC-32: 2 SPDT.
Load (cosφ= 1):	Max. 380V AC/2A, 240V AC/5A, 30V DC/5A.
Mechanical lifetime:	Min. 10 x 10 ⁶ operations.
Electrical lifetime:	Min. 100.000 operations at max. load.
On -/release delay:	Individually programmable 0-100.0sec, 0.1sec. resolution.
Terminals:	1.5 mm ² plug-in screw terminals.
Supply voltage:	24V DC (19.2-28.8V), 24V AC (19.2-28.8V), 48V AC (38.4-57.6V), 110/120V AC (88-132V), 220/240V AC(176-264V).
Mains frequency:	45-66Hz.
Consumption:	3VA.
Protection:	
Front:	IP54 (IP65 on request),
Rear:	IP20.
Ambient temperature:	-10-55°C.
Isolation:	
AC versions:	4kV AC according to EN 60950 class II.
12, 24, 48V DC:	500V.
Dimensions:	According to DIN 43700.
Front:	96 x 48 mm.
Cut-out:	91 x 43 mm.
Depth:	88 mm + frame 7 mm + terminals 10 mm.
Housing:	
Front:	Plastic.
House:	Self-extinguishing ABS.
Weight:	300-415 g.

NOTES/REMARKS

- 1) With external shunt type AAS-010 (0-10.0 A DC) or type AAS-100 (0-100 A DC).
- 3) Special range. Please specify input.
- 4) Extended measuring range can be obtained by using external current transformer.

INTRO...
UDM-10
UDM-20
UDC-32
UDC-35

AC/DC VOLTAGE

DESCRIPTION

Input for direct measurement of AC or DC voltages up to 500V. The AC input is equipped with a true RMS rectifier for accurate AC measurement.

The facilities of the UDC-32 with two setpoints and output relays with programmable time delay and hysteresis make the UDC-32 suited for advanced voltage monitoring and control.

Typical applications:

- Monitoring and alarm systems (over/undervoltage).
- Generator control systems.
- Battery charge control.
- Battery monitoring and control in power back-up systems.

MEASURING RANGES

AC	DC
0-99.99V	0-99.99V
0-500.0V	0-500.0V

Other ranges are available on request.

Input impedance:

- AC: 1kOhm/V.
- DC: 1MOhm (>10V).

Measuring accuracy:

- AC: 0.3% of full scale ± 1 digit.
- DC: 0.1% of full scale ± 1 digit.

WIRING DIAGRAMS

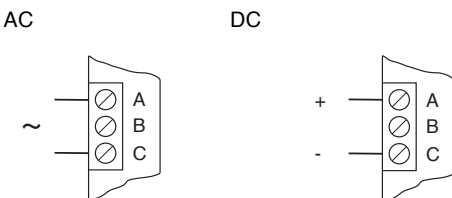

AC/DC CURRENT

DESCRIPTION

Input for direct measurement of AC or DC current up to 200mA DC or 5A AC. The measuring range is easily extended by adapting an external shunt or current transformer.

The AC input is equipped with a true RMS rectifier for accurate AC measurement.

The facilities with two setpoints/output relays, programmable time delay and hysteresis make the UDC-32 suitable for advanced current monitoring and control.

Typical applications:

- General alarm and monitoring applications.
- Monitoring/protection of motors.
- Battery charge control.
- Overload protection.

MEASURING RANGES

AC		DC	
0-200.0mA		0-99.99mA	
0-5.000A		0-200.0mA	
0-200A	with external current transformer (1A sec.)	0-10.00A	with external shunt (60mV voltage drop)
0-500A		0-100.0A	

Other ranges are available on request.

Input impedance:

- 1V
- I max.
- 60mV with shunt.
- I max

Measuring accuracy:

- AC: 0.3% of full scale ± 1 digit.
- DC: 0.1% of full scale ± 1 digit.

WIRING DIAGRAMS

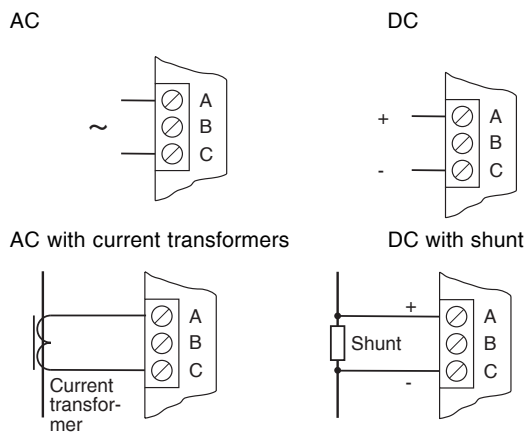

TEMPERATURE

DESCRIPTION

Input for all types of temperature sensors, both thermocouples and resistor types.

High measuring accuracy is obtained over a wide temperature range by the microprocessor's compensation for nonlinearity in the sensor signal.

The two output relays and the extensive programming facilities make the UDC-32 suitable for most temperature control and monitoring applications.

Typical applications:

General temperature control and monitoring applications.
Wide range temperature measurement with high accuracy.
Temperature with separate control and alarm output.

MEASURING RANGES

RTDs/Thermistors			
Pt-100/500/1000	Ni-100	Thermistor (KTY)	
- 19.95- 99.95°C	-50.0-300.0°C	30.0-100.0°C	
-50.0-300.0°C			
-50-850°C			
Thermocouples			
Fe-CuNi	NiCr-Ni	PtRh-Pt 10%	PtRh-Pt 13%
-50-1200°C	-50-1350°C	-50 -1750°C	-50-1750°C

Measuring accuracy: 0.1% of full scale ± 1 digit.

Resolution: Min. 0.5°C.

WIRING DIAGRAMS

RTD/Thermistor (2-wire)

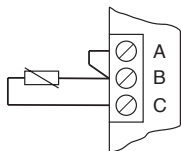

RTD/Thermistor (3-wire)

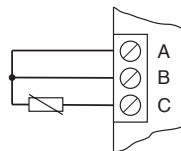

Thermocouple

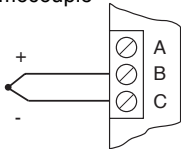

STANDARD PROCESS SIGNAL

DESCRIPTION

The programming facilities of the UDC-32 make it ideal as monitor or control device for normal standard process signals, e.g. 4-20mA. Any output from a transmitter can be scaled to engineering units by using the scale and correction facilities in the UDC-31/32.

The flexibility of the 2 output relays enables the UDC-32 to perform any type of control or monitoring related to the process signal. Time delays and hysteresis are programmable.

Typical applications:

General process instrumentation.
Signal converter and monitor with 2-level control output.

MEASURING RANGE

DC

0-20mA/0-10V.
Other standard process signals within these limits can be used as the scale of the controller is fully programmable.

Measuring accuracy: 0.1% of full scale ± 1 digit.

Input impedance:

Voltage: 1Mohm.
Current: 50Ohm.

WIRING DIAGRAMS

Voltage

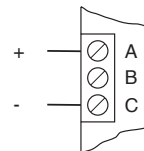

Current

